

ELEVATION

Section :- A - A

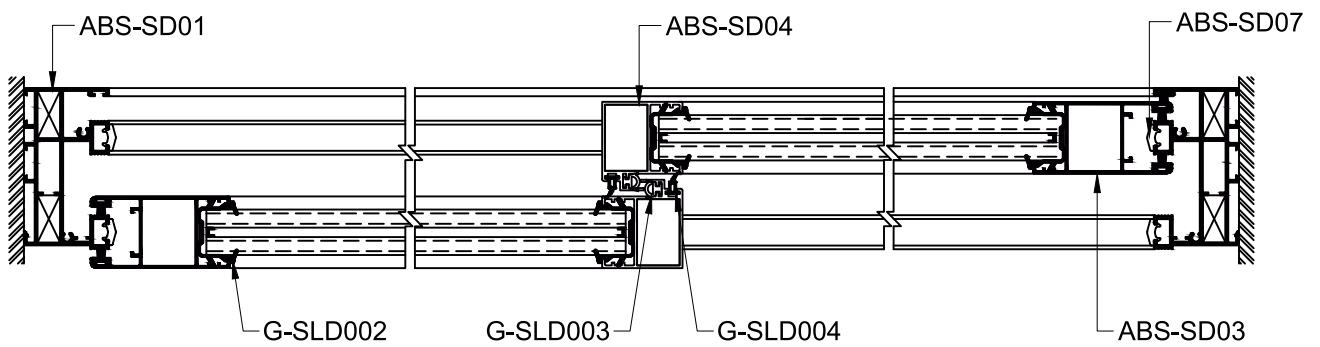

Section :- B - B

PERFORMANCE TESTS WERE CONDUCTED IN A UKAS ACCREDITED LAB

ABS Sliding

Group 06
Page 02

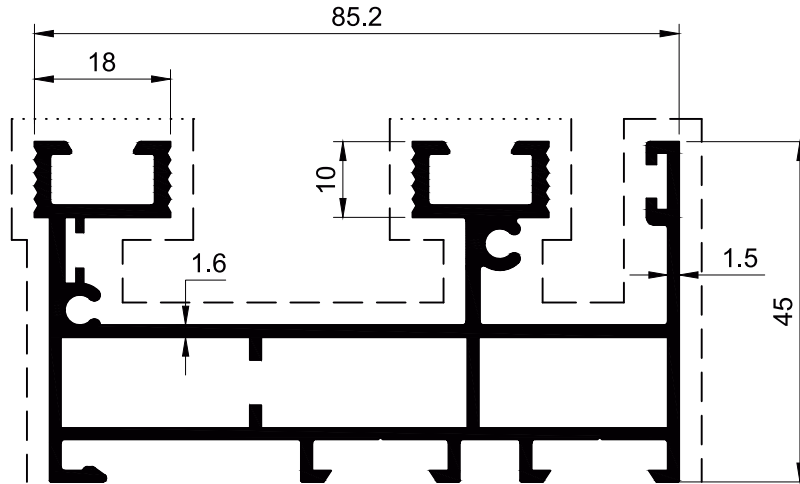

SECTION NO. - ABS-SD01
EST. WEIGHT - 1.779 KG./M.

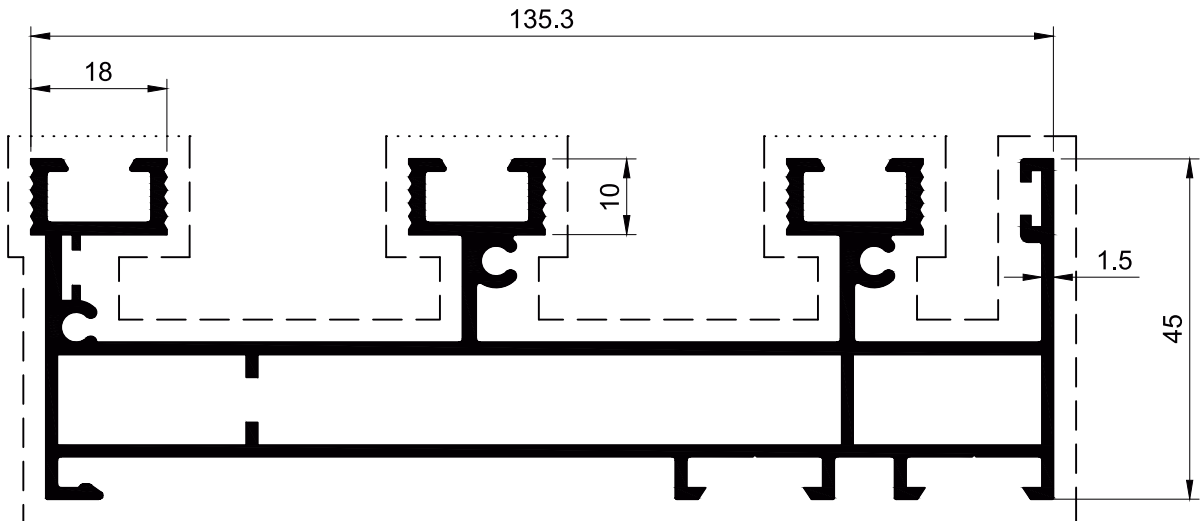

SECTION NO. - ABS-SD02
EST. WEIGHT - 2.506 KG./M.

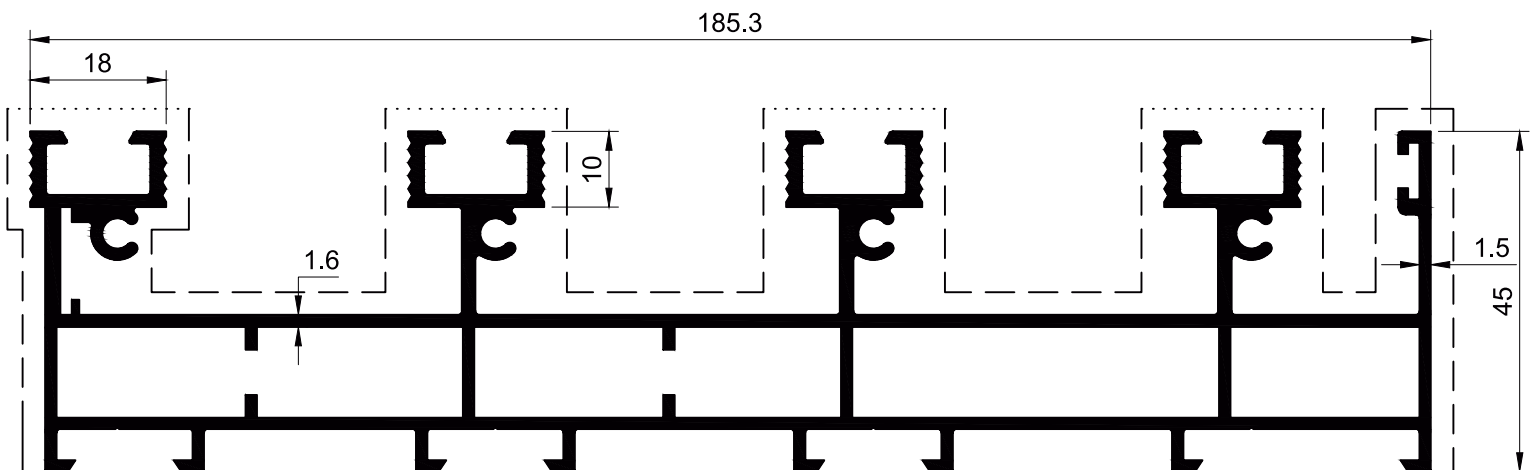

SECTION NO. - ABS-SD12
EST. WEIGHT - 3.476 KG./M.

----- : Significant Surface
..... : Insignificant Surface

ABS Sliding

Group 06
Page 03

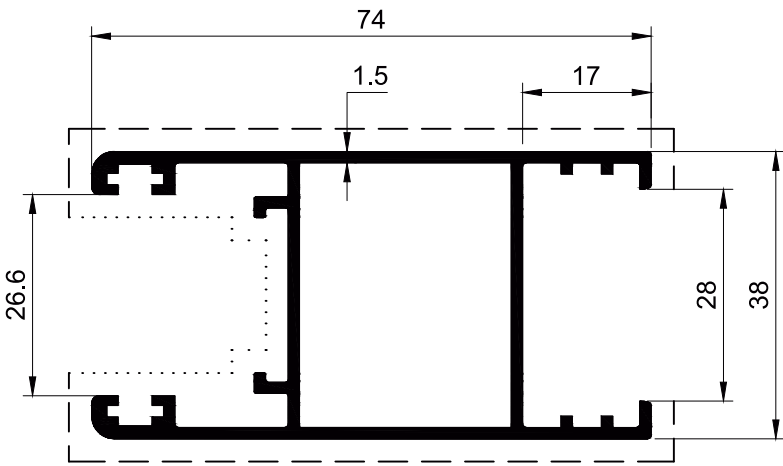

SECTION NO. - ABS-SD03
EST. WEIGHT - 1.099 KG./M.

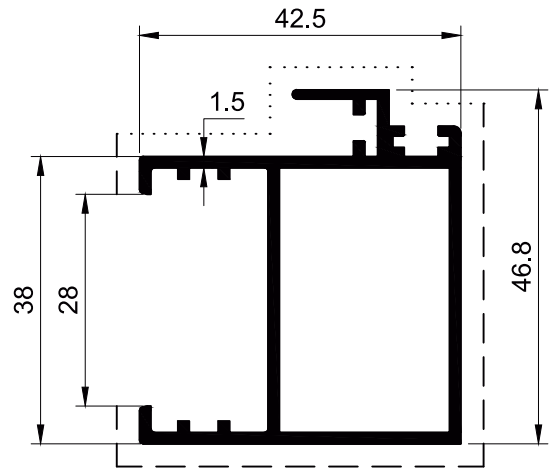

SECTION NO. - ABS-SD04
EST. WEIGHT - 0.809 KG./M.

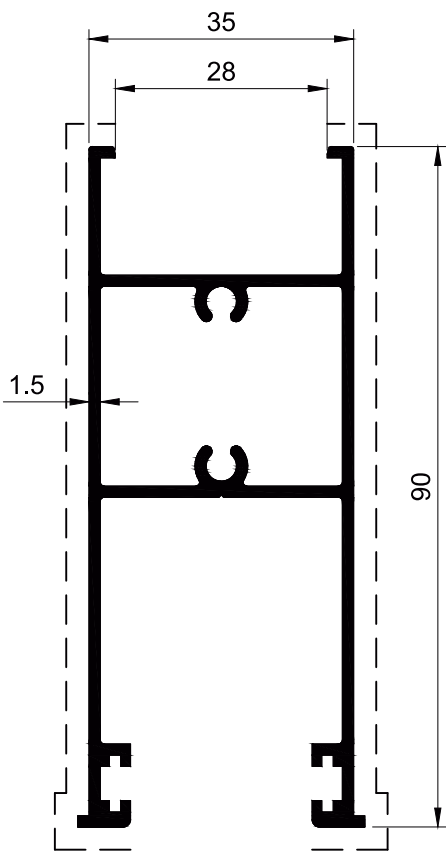

SECTION NO. - ABS-SD05
EST. WEIGHT - 1.224 KG./M.

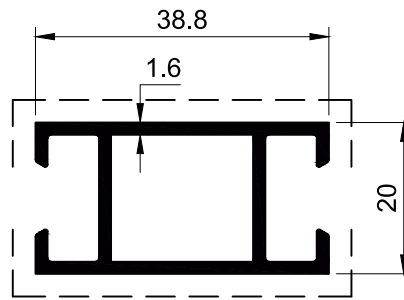

SECTION NO. - ABS-SD06
EST. WEIGHT - 0.550 KG./M.

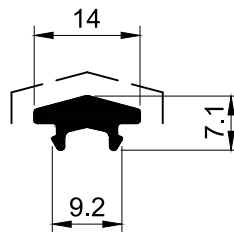

SECTION NO. - ABS-SD07
EST. WEIGHT - 0.138 KG./M.

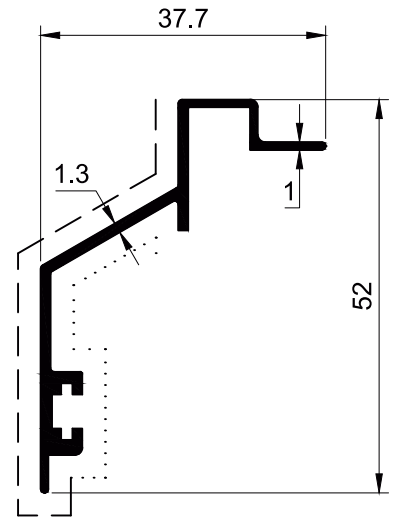

SECTION NO. - ABS-SD11
EST. WEIGHT - 0.359 KG./M.

----- : Significant Surface
..... : Insignificant Surface

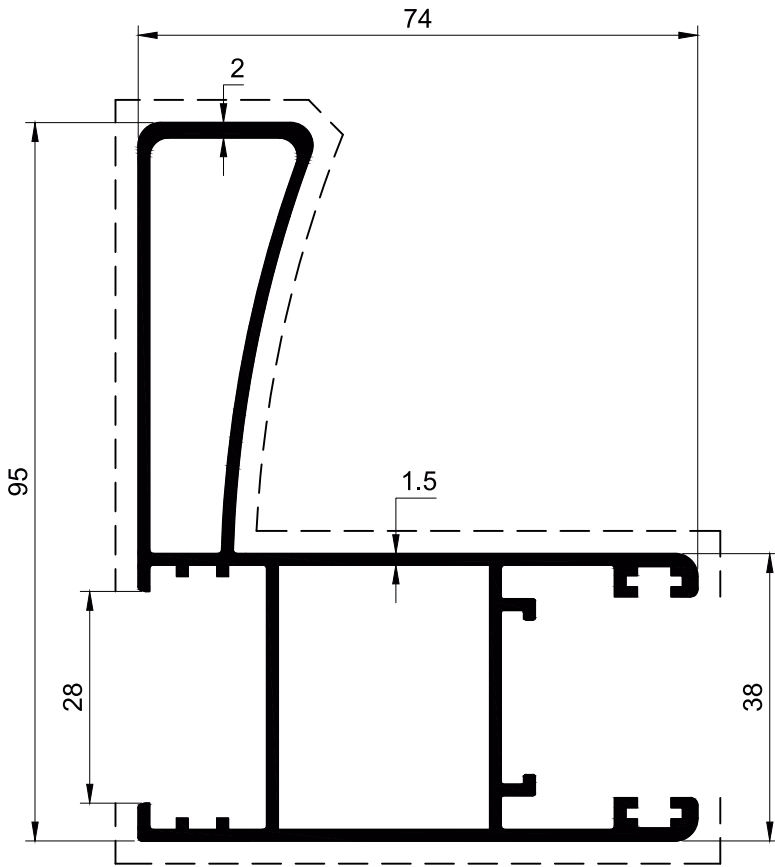

SECTION NO. - ABS-SD08
EST. WEIGHT - 1.669 KG./M.

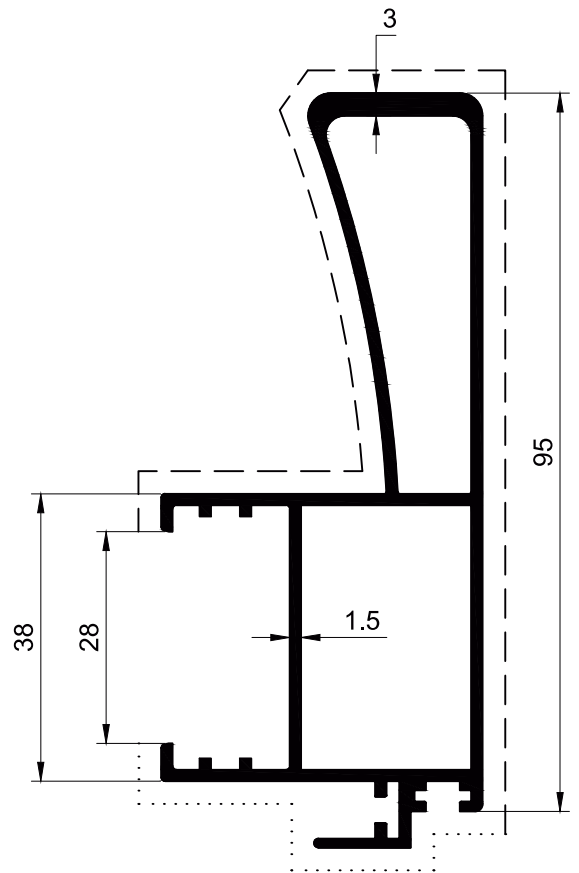

SECTION NO. - ABS-SD09
EST. WEIGHT - 1.403 KG./M.

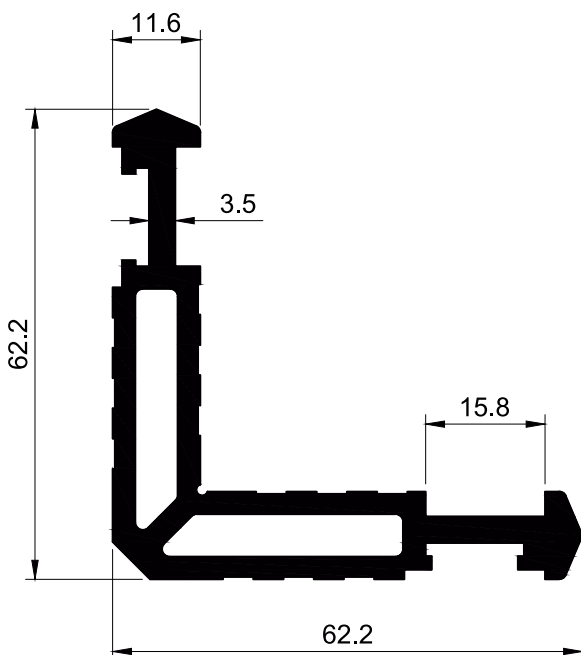

SECTION NO. - ABS-SD10
EST. WEIGHT - 1.825 KG./M.

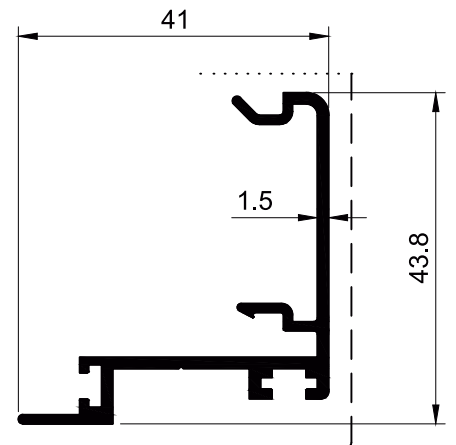

SECTION NO. - ABS-SD15
EST. WEIGHT - 0.490 KG./M.

----- : Significant Surface
..... : Insignificant Surface

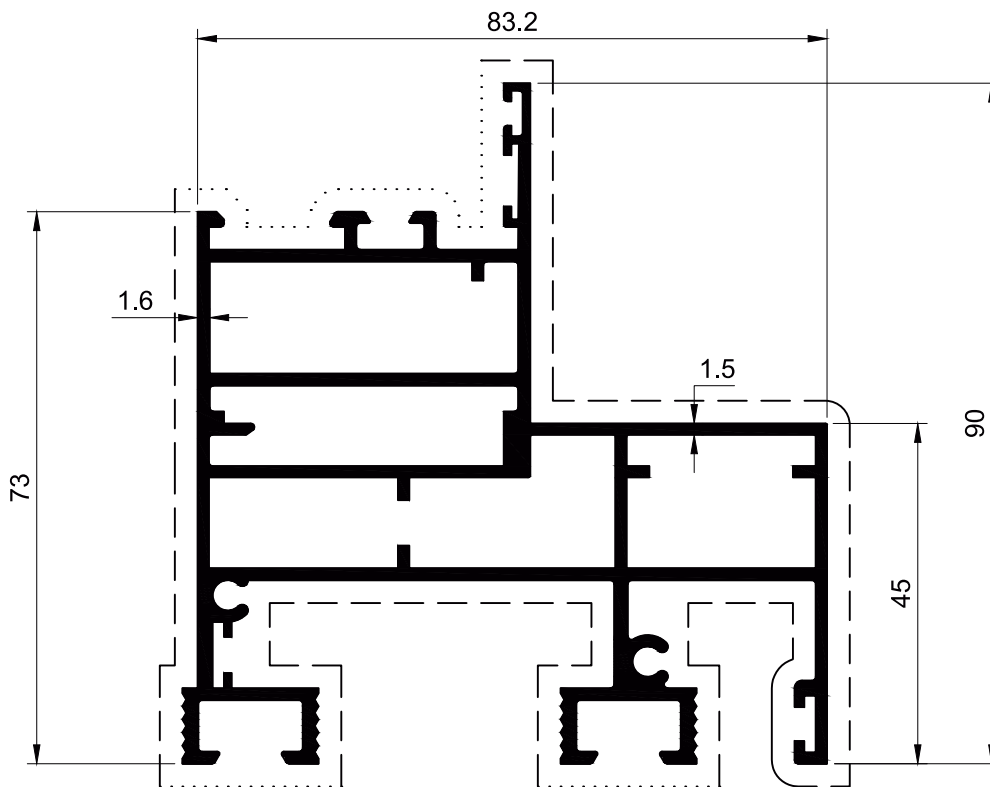

SECTION NO. - ABS-SD13
EST. WEIGHT - 2.563 KG./M.

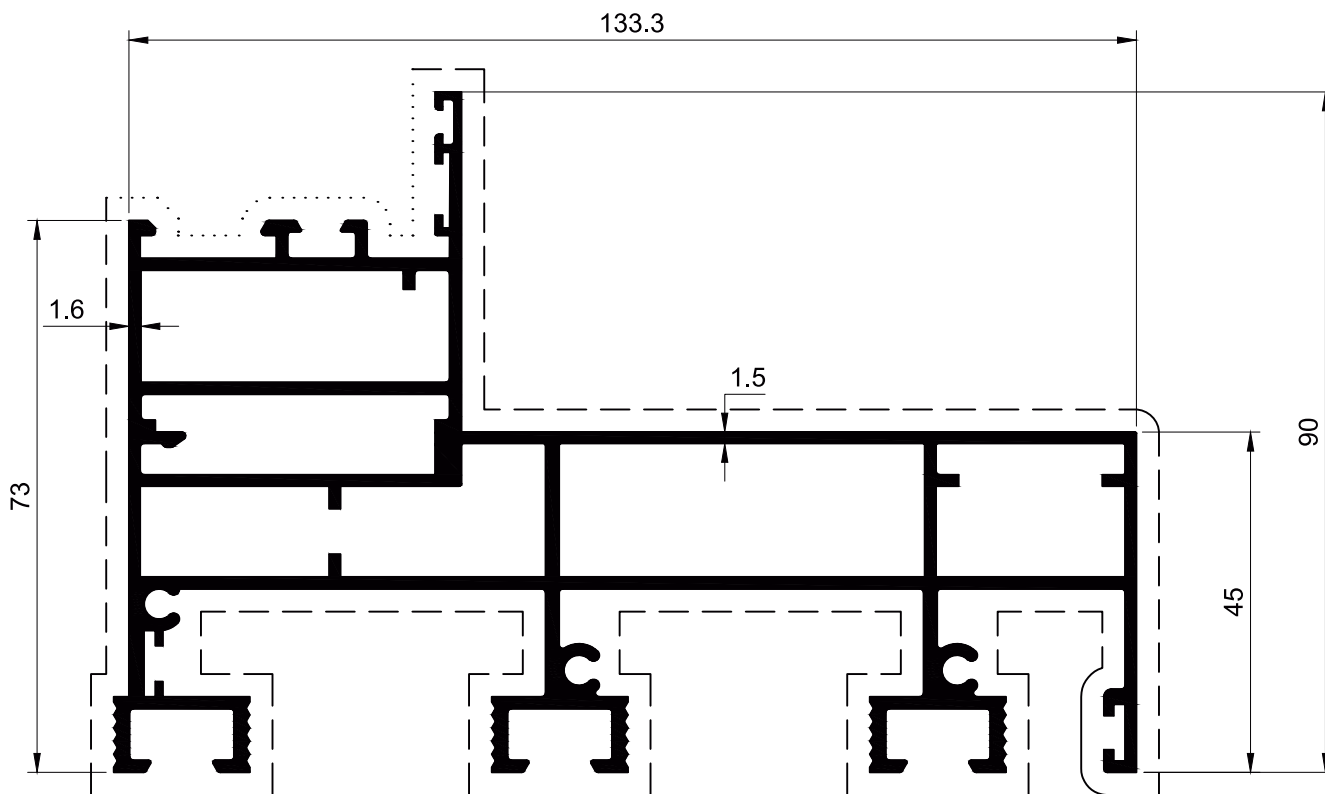

SECTION NO. - ABS-SD14
EST. WEIGHT - 3.377 KG./M.

----- : Significant Surface
..... : Insignificant Surface